

**General Purpose NPN / PNP Epitaxial Planar Transistors
 (dual transistors)**

HBNP45C6

Features

- Includes a BTC2412 chip and a BTA1037 chip in a SOT-563 package.
- Mounting possible with SOT-523 automatic mounting machines.
- Transistor elements are independent, eliminating interference.
- Mounting cost and area can be cut in half.
- Pb-free lead plating and halogen-free package.

Equivalent Circuit

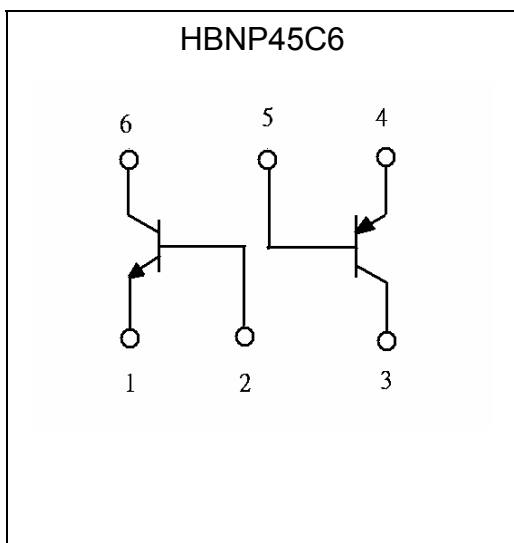

Outline

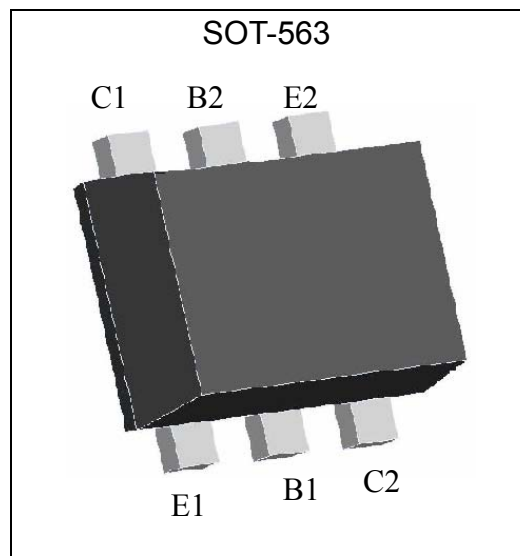

Absolute Maximum Ratings (Ta=25°C)

Parameter	Symbol	Limits		Unit
		TR1 (NPN)	TR2 (PNP)	
Collector-Base Voltage	V _{CB0}	60	-60	V
Collector-Emitter Voltage	V _{CE0}	50	-50	V
Emitter-Base Voltage	V _{EB0}	7	-6	V
Collector Current	I _C	150	-150	mA
Power Dissipation	P _d	150(total) *1		mW
Junction Temperature	T _j	150		°C
Storage Temperature	T _{stg}	-55~+150		°C

Note: *1 120mW per element must not be exceeded.

**Characteristics** (Ta=25°C)**• TR1 (NPN)**

Symbol	Min.	Typ.	Max.	Unit	Test Conditions
BV _{CBO}	60	-	-	V	I _C =100μA
BV _{CEO}	50	-	-	V	I _C =1mA
BV _{EBO}	7	-	-	V	I _E =50μA
I _{CBO}	-	-	0.1	μA	V _{CB} =60V
I _{EBO}	-	-	0.1	μA	V _{EB} =7V
*V _{CE(sat)}	-	0.2	0.4	V	I _C =50mA, I _B =5mA
*h _{FE}	200	-	600		V _{CE} =6V, I _C =1mA
f _T	80	180	-	MHz	V _{CE} =12V, I _C =2mA, f=100MHz
Cob	-	2	3.5	pF	V _{CB} =12V, f=1MHz

*Pulse Test: Pulse Width ≤380μs, Duty Cycle≤2%

• TR2 (PNP)

Symbol	Min.	Typ.	Max.	Unit	Test Conditions
BV _{CBO}	-60	-	-	V	I _C =-50μA
BV _{CEO}	-50	-	-	V	I _C =-1mA
BV _{EBO}	-6	-	-	V	I _E =-50μA
I _{CBO}	-	-	-0.1	μA	V _{CB} =-60V
I _{EBO}	-	-	-0.1	μA	V _{EB} =-6V
*V _{CE(sat)}	-	-0.25	-0.5	V	I _C =-50mA, I _B =-5mA
*h _{FE}	200	-	600		V _{CE} =-6V, I _C =-1mA
f _T	60	140	-	MHz	V _{CE} =-12V, I _C =-2mA, f=100MHz
Cob	-	4	5	pF	V _{CB} =-12V, f=1MHz

*Pulse Test: Pulse Width ≤380μs, Duty Cycle≤2%

Ordering Information

Device	Package	Shipping
HBNP45C6-0-T1-G	SOT-363 (Pb-free lead plating and halogen-free package)	3000 pcs / Tape & Reel

Characteristic curves

• TR1 (NPN)

Current Gain vs Collector Current

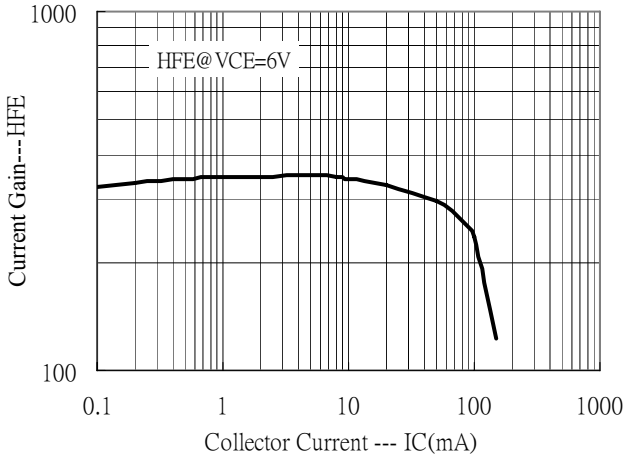

Saturation Voltage vs Collector Current

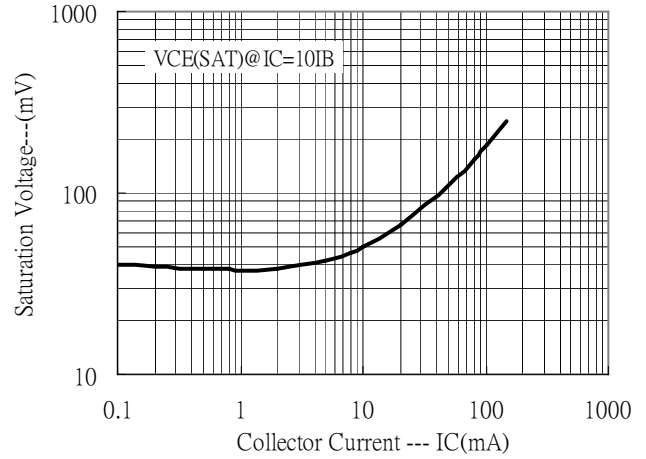

Saturation Voltage vs Collector Current

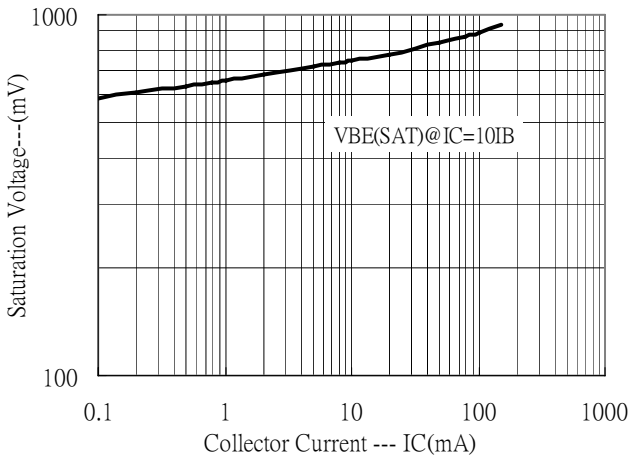

Cutoff Frequency vs Collector Current

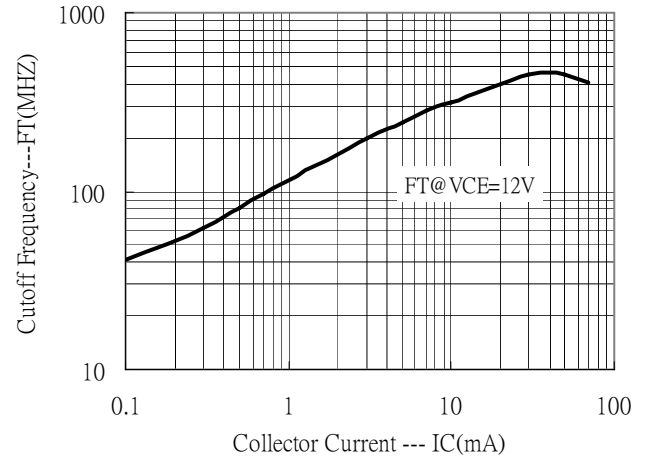

Capacitance Characteristics

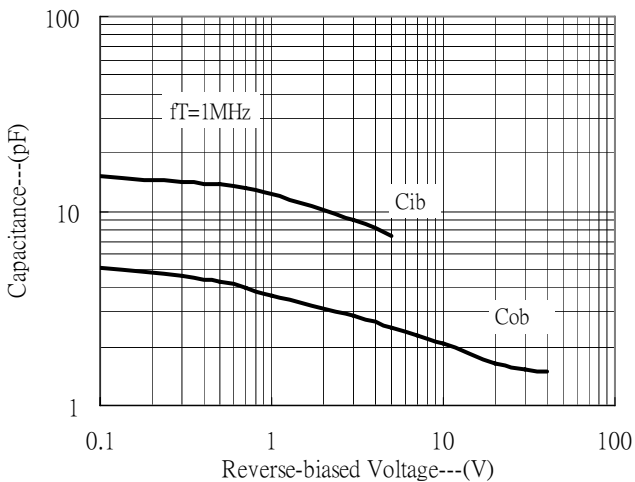

• **TR2 (PNP)**

Current Gain vs Collector Current

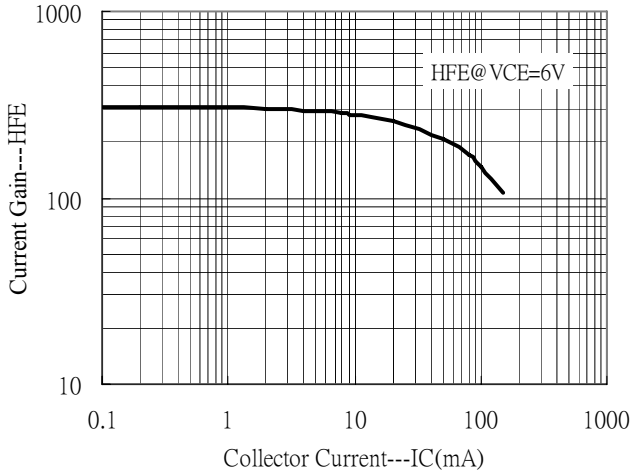

Saturation Voltage vs Collector Current

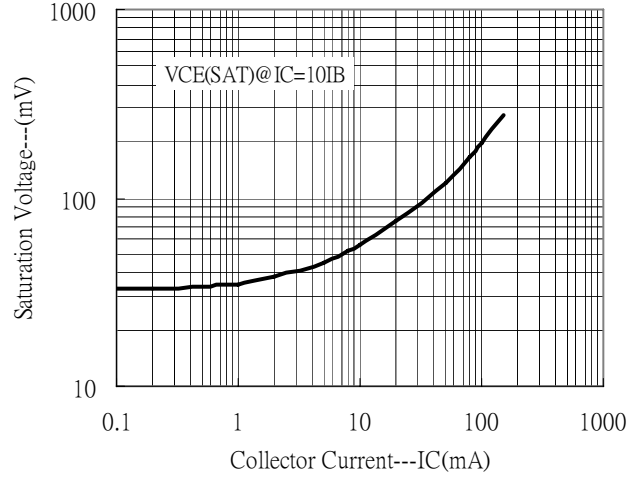

Saturation Voltage vs Collector Current

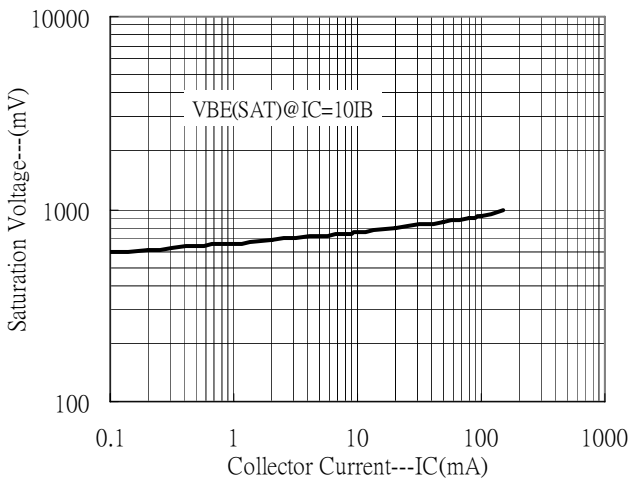

Cutoff Frequency vs Collector Current

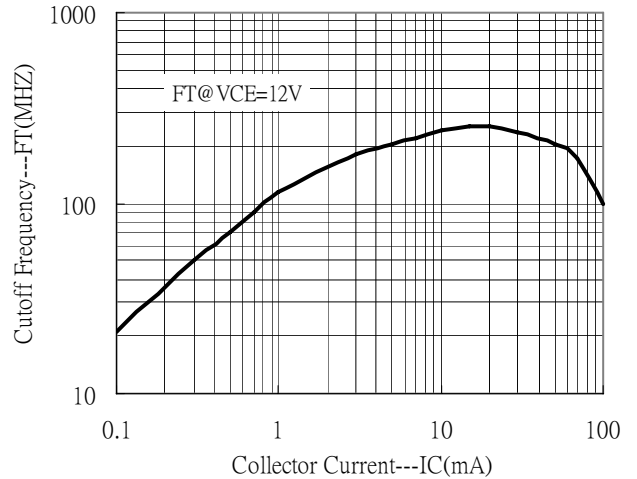

Capacitance Characteristics

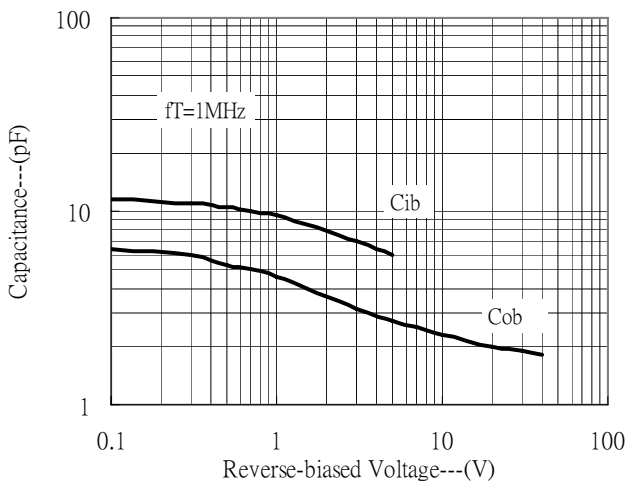

Power Derating Curves

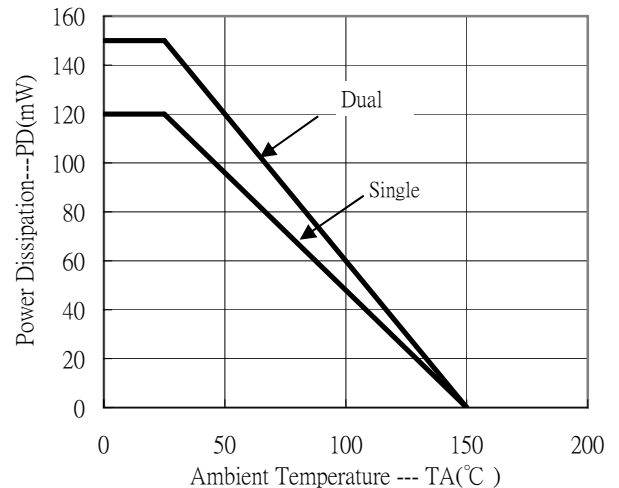

Reel Dimension

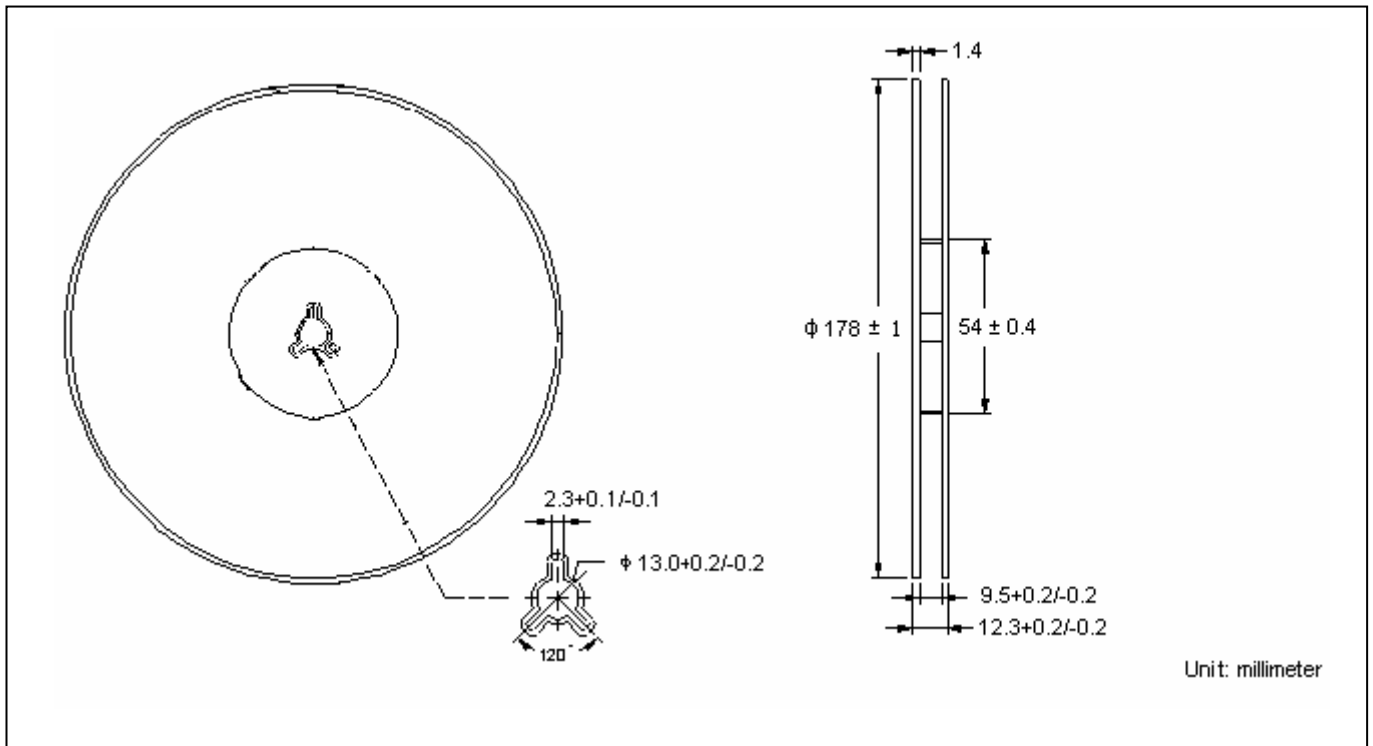

Carrier Tape Dimension

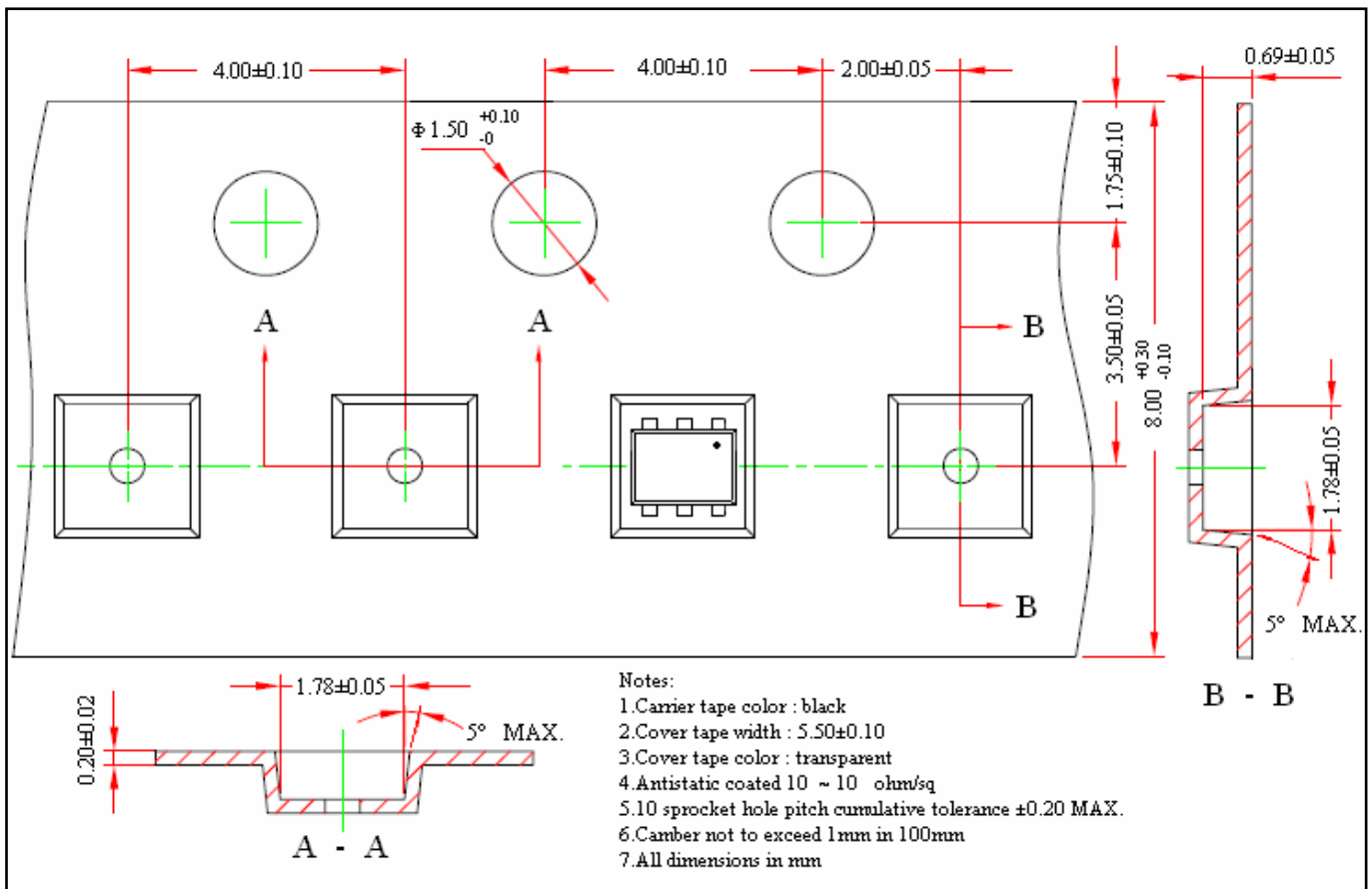

Recommended wave soldering condition

Product	Peak Temperature	Soldering Time
Pb-free devices	260 +0/-5 °C	5 +1/-1 seconds

Recommended temperature profile for IR reflow

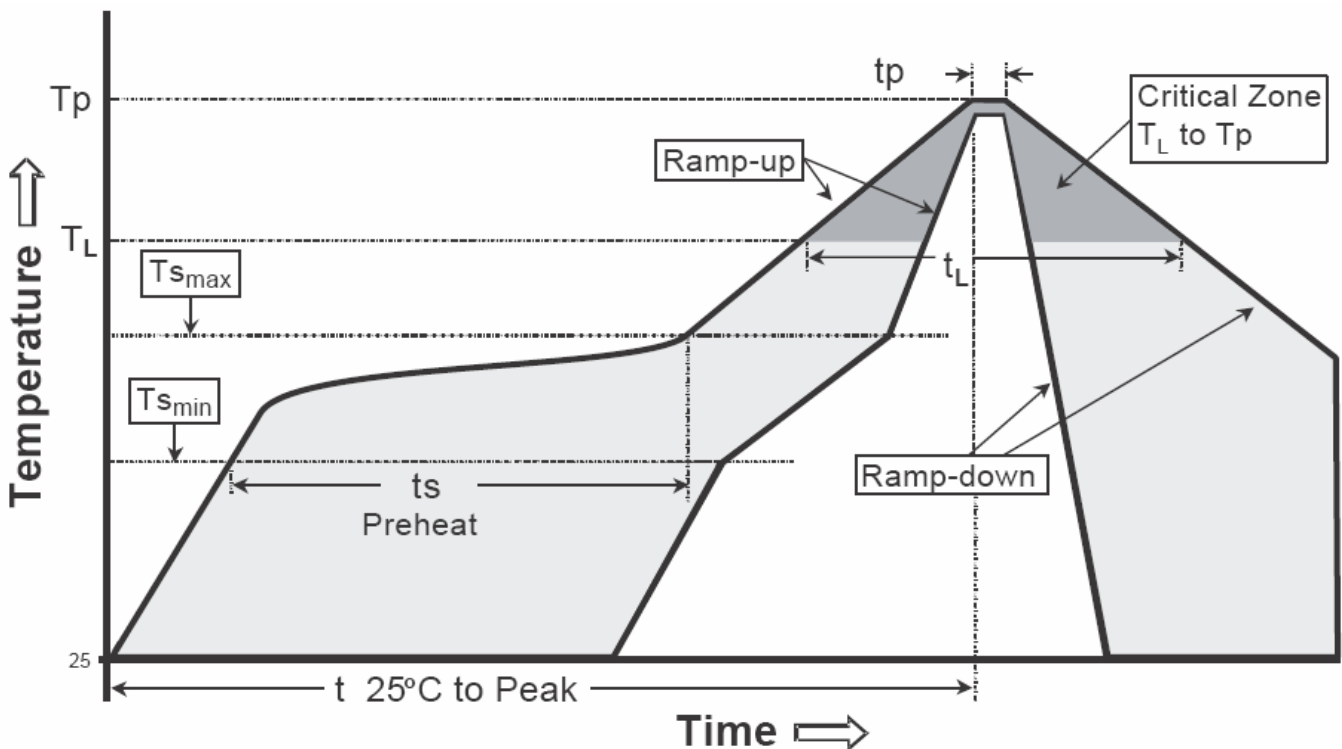

Profile feature	Sn-Pb eutectic Assembly	Pb-free Assembly
Average ramp-up rate (T _{smax} to T _p)	3°C/second max.	3°C/second max.
Preheat		
-Temperature Min(T _{s min})	100°C	150°C
-Temperature Max(T _{s max})	150°C	200°C
-Time(t _{s min} to t _{s max})	60-120 seconds	60-180 seconds
Time maintained above:		
-Temperature (T _L)	183°C	217°C
- Time (t _L)	60-150 seconds	60-150 seconds
Peak Temperature(T _P)	240 +0/-5 °C	260 +0/-5 °C
Time within 5°C of actual peak temperature(tp)	10-30 seconds	20-40 seconds
Ramp down rate	6°C/second max.	6°C/second max.
Time 25 °C to peak temperature	6 minutes max.	8 minutes max.

SOT-563 Dimension

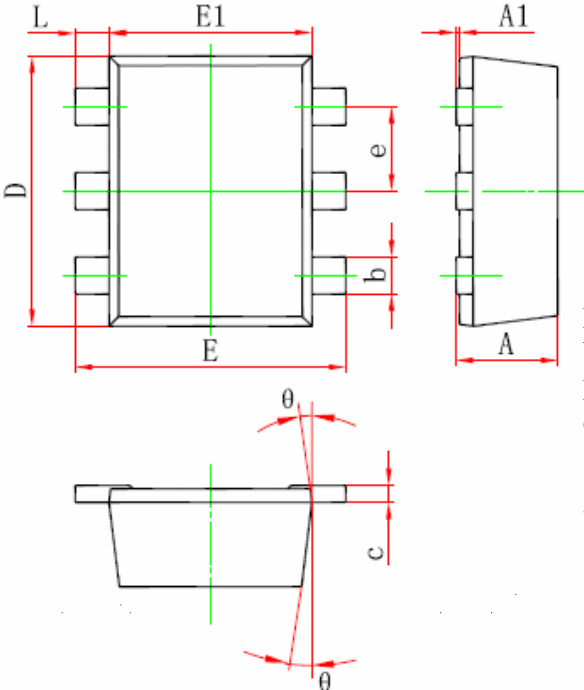

The diagram shows three views of the SOT-563 package: a top view with dimensions L, E1, E, D, e, b, and θ ; a side view with dimensions A1 and A; and a perspective view of the lead with dimension c and angle θ .

Marking:

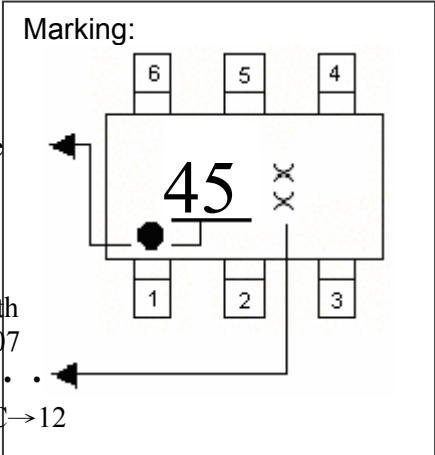

The marking diagram shows a top-down view of the package with pins numbered 1 to 6. The marking includes the number '45', 'XX', and a 'Product Code' area.

Date Code: Year+Month
 Year: 6→2006, 7→2007
 Month: 1→1, 2→2, . . .
 9→9, A→10, B→11, C→12

Style:
 Pin 1. Emitter1 (E1)
 Pin 2. Base1 (B1)
 Pin 3. Collector2 (C2)
 Pin 4. Emitter2 (E2)
 Pin 5. Base2 (B2)
 Pin 6. Collector1 (C1)

6-Lead SOT-563 Plastic Surface Mounted Package
 CYStek Package Code: C6

DIM	Inches		Millimeters		DIM	Inches		Millimeters	
	Min.	Max.	Min.	Max.		Min.	Max.	Min.	Max.
A	0.021	0.024	0.525	0.600	b	0.007	0.011	0.170	0.270
A1	0.000	0.002	0.000	0.050	E1	0.043	0.051	1.100	1.300
e	0.018	0.022	0.450	0.550	E	0.059	0.067	1.500	1.700
c	0.004	0.006	0.090	0.160	L	0.004	0.012	0.100	0.300
D	0.059	0.067	1.500	1.700	θ	7° REF		7° REF	

Notes : 1.Controlling dimension : millimeters.
 2.Maximum lead thickness includes lead finish thickness, and minimum lead thickness is the minimum thickness of base material.
 3.If there is any question with packing specification or packing method, please contact your local CYStek sales office.

Material :

- Lead : Pure tin plated.
- Mold Compound : Epoxy resin family, flammability solid burning class:UL94V-0.

Important Notice:

- All rights are reserved. Reproduction in whole or in part is prohibited without the prior written approval of CYStek.
- CYStek reserves the right to make changes to its products without notice.
- CYStek **semiconductor products are not warranted to be suitable for use in Life-Support Applications, or systems.**
- CYStek assumes no liability for any consequence of customer product design, infringement of patents, or application assistance.